



40640





Get excited about our new packaging!

We're switching from plastic to paper-based packaging. That's why you might find a mix of paper and plastic in our boxes!

Nos nouveaux emballages vous emballeront !

Nous passons des emballages en plastique aux emballages à base de papier. C'est pourquoi vous pourriez trouver un mélange de papier et de plastique dans nos boîtes !

¡Te presentamos nuestros nuevos empaques!

Estamos sustituyendo las bolsas de plástico por bolsas con base de papel. ¡Por eso, puedes encontrar una mezcla de papel y de plástico en nuestras cajas!

[LEGO.com/sustainable-packaging](https://www.lego.com/sustainable-packaging)

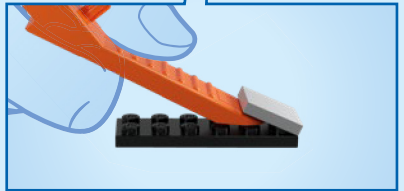
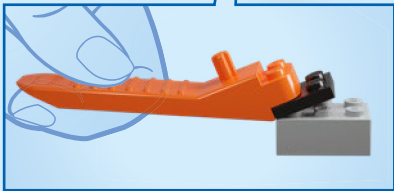
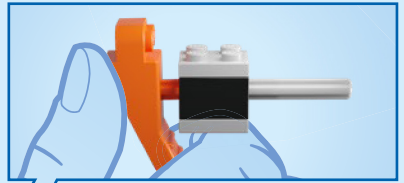
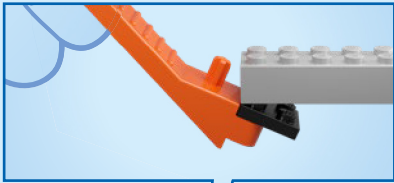



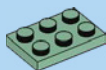

1x



1x

1

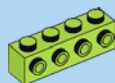
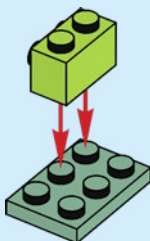

1x

2

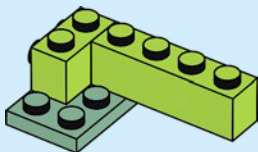



1x

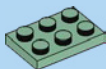

1x

3

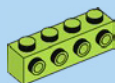
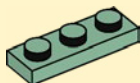
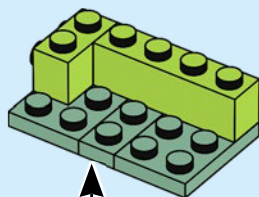

1x



1x

4

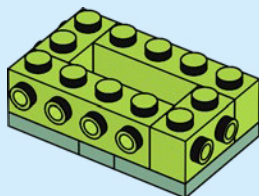

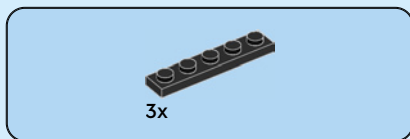

5

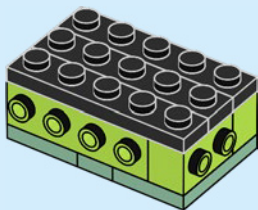

6

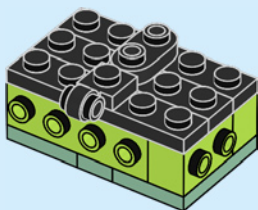



2x

7

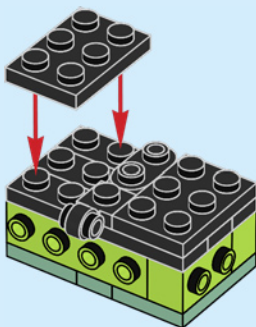

3x

8

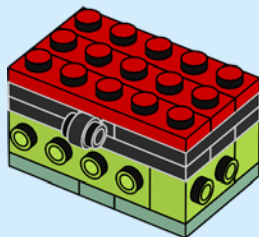



1x



1x

9

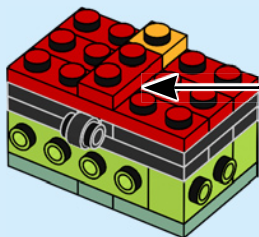

1x



1x



1x

10

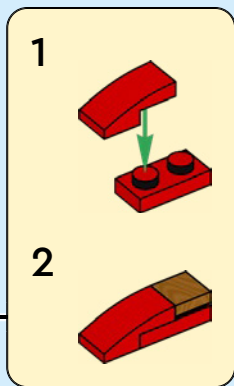
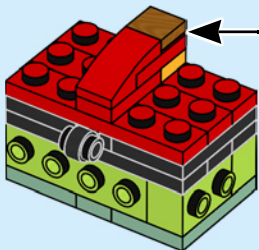

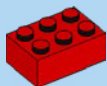

2x

11

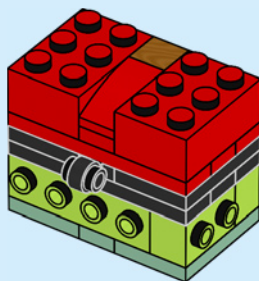

2x



2x



2x

12

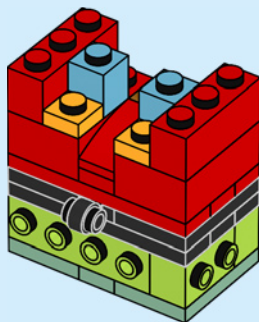

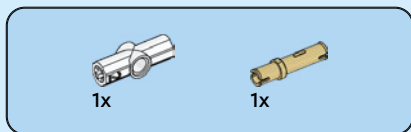
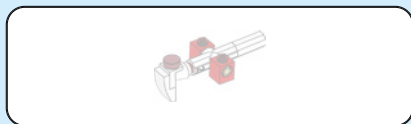

13

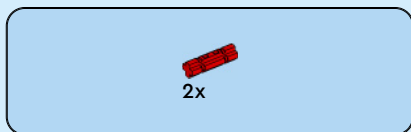
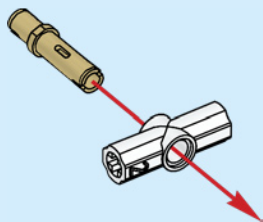

14

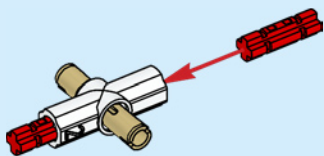



1x

15

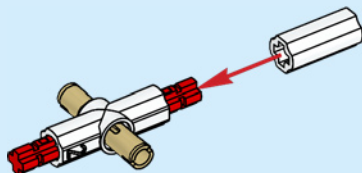

1x



1x



1x



1x

16

1

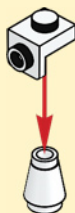

2

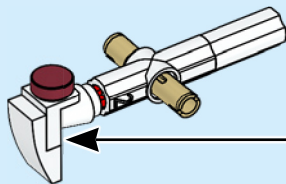
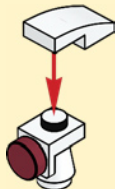



2x

17

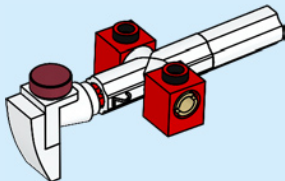

18

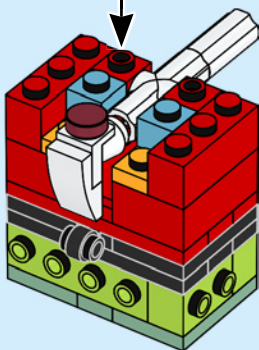



2x

19

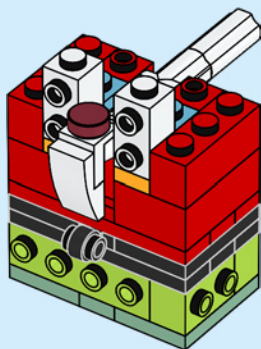

2x



2x

20

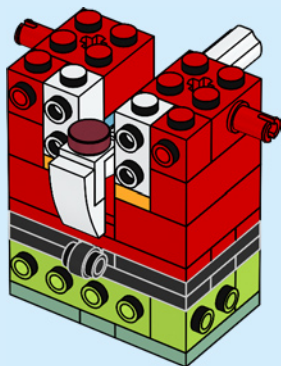



2x



1x

21

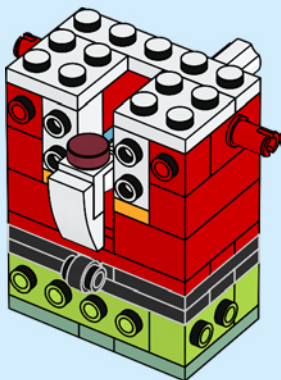

6x



1x

22

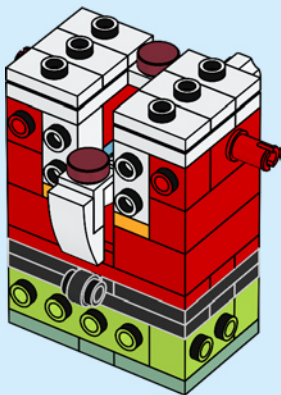

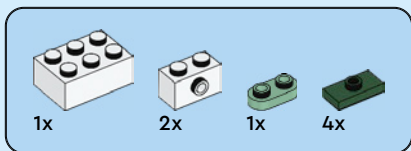

23

1

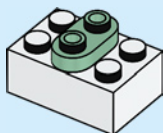

2

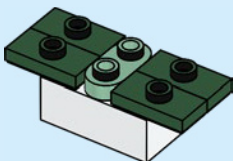

3

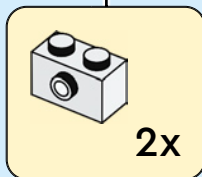
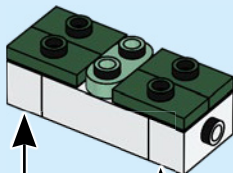

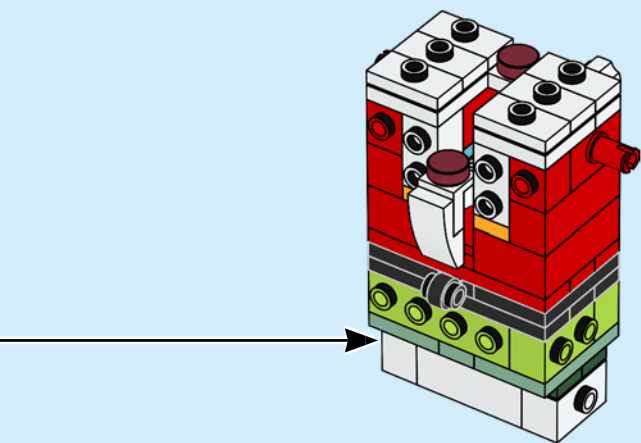



2x

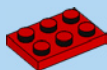

2x



4x



4x



2x



4x



2x

24

1

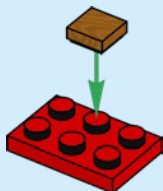

2



3

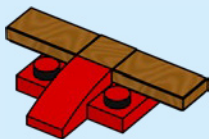

4

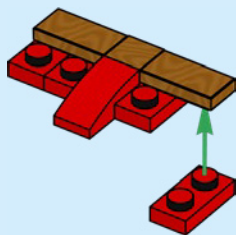

5

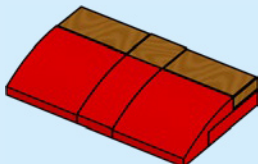

2x

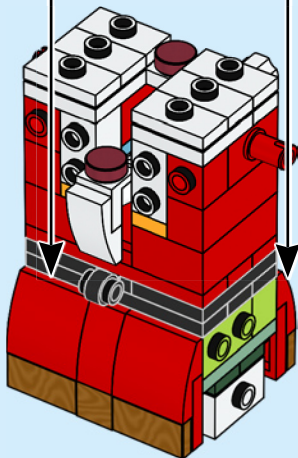

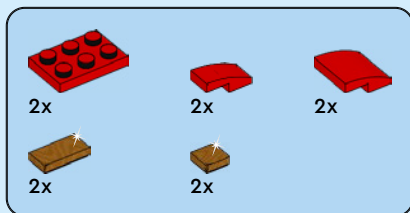

25

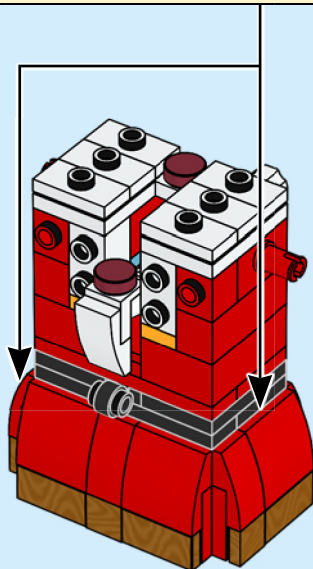
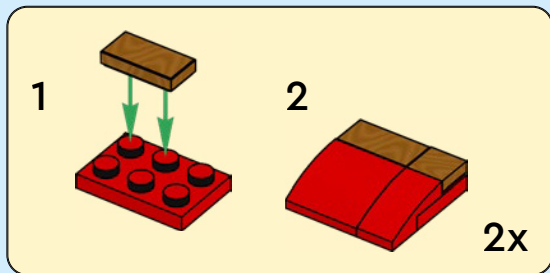



2x

26

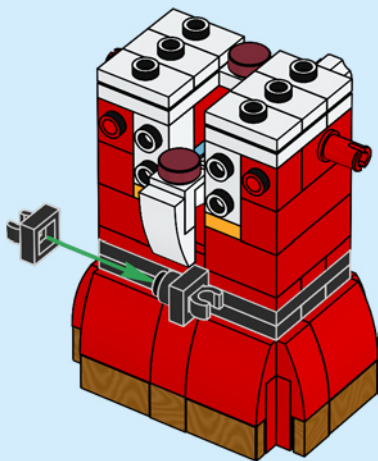



2x



1x



1x

27

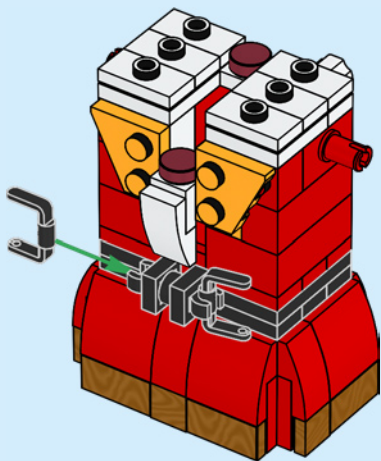

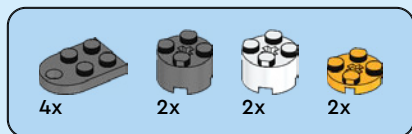

28

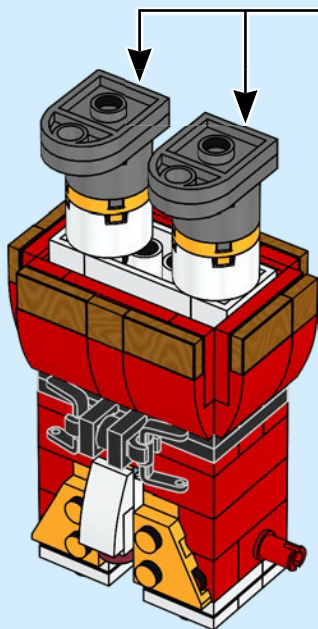
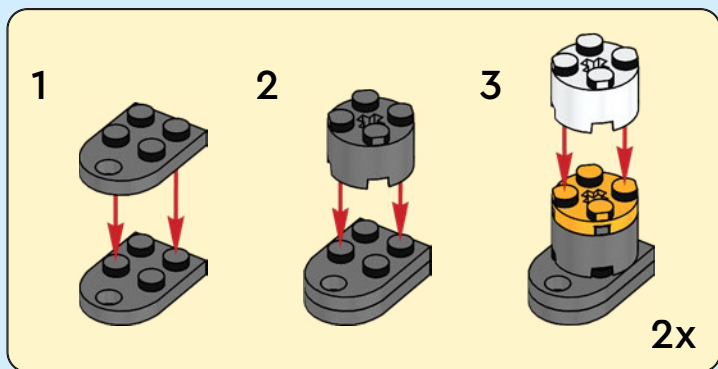



2x



2x



4x



2x



2x



2x



2x

3

29

1

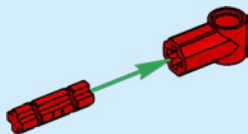

2

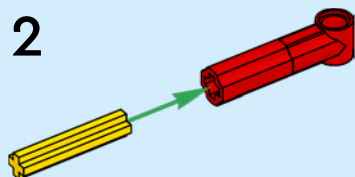

3

3

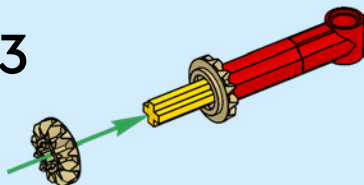

4

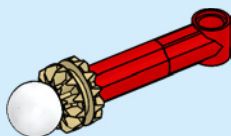

2x



3

1:1

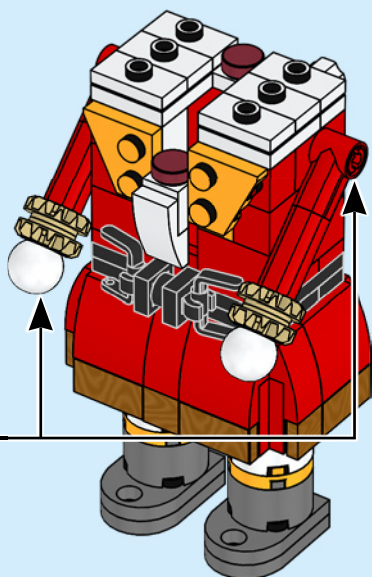



2x



2x

30

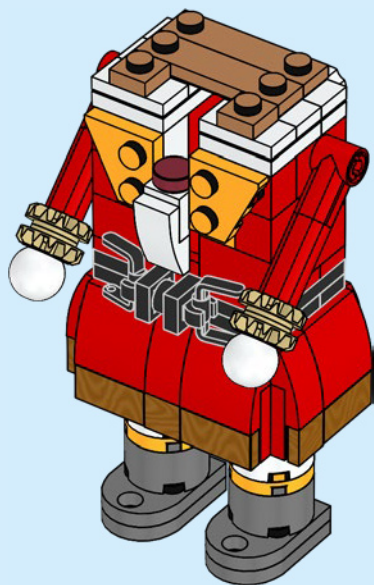

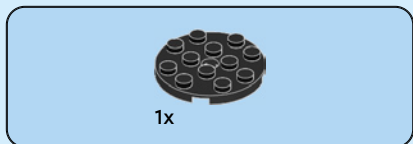

31

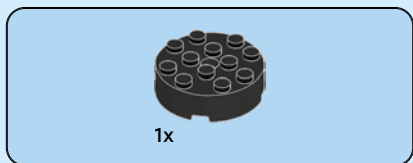

32

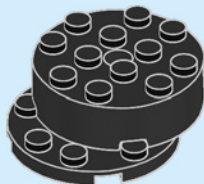



1x

33

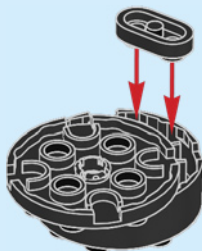

1x

34

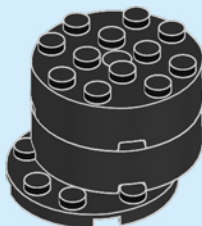



1x

35

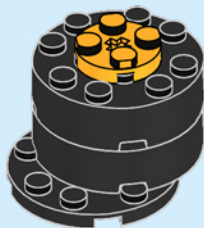

2x



1x

36

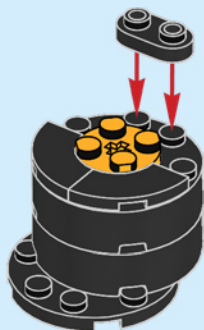

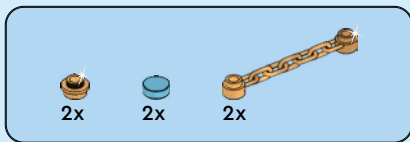

37

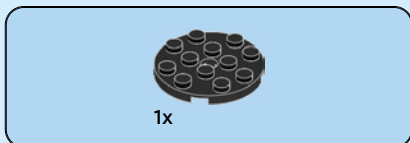
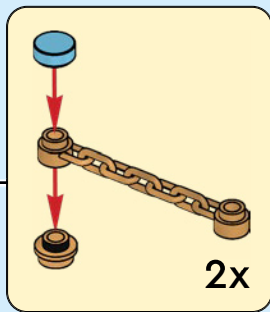
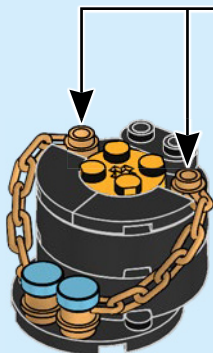

38





1x

39

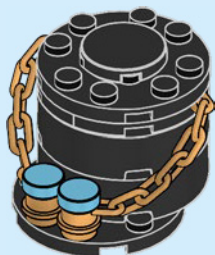

4x

40



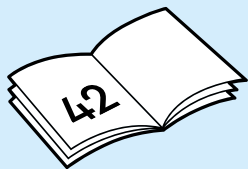
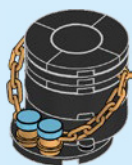

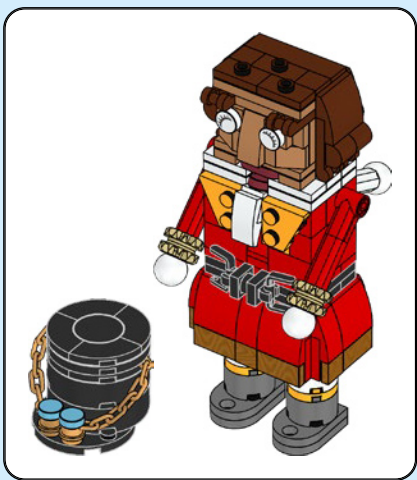

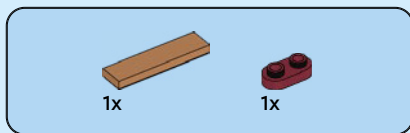

41

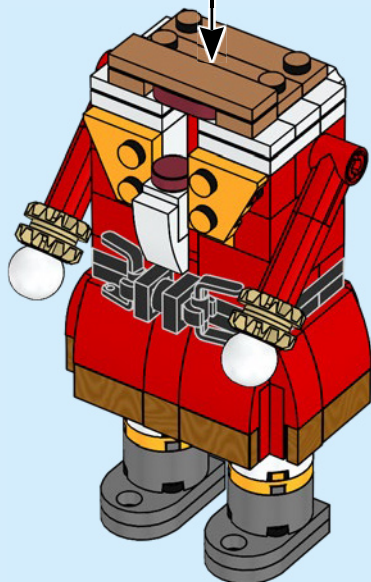
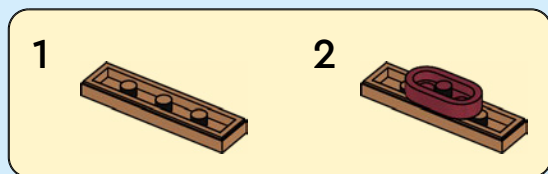



1x

42



2x

43



2x



1x

44

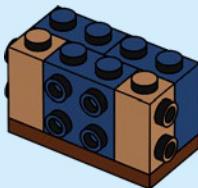
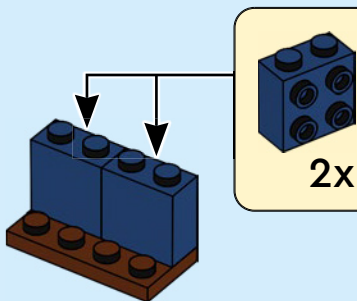
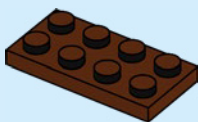

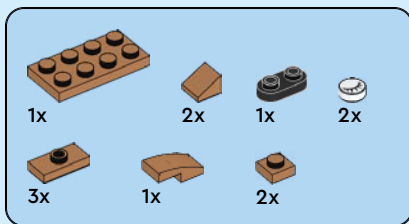

45

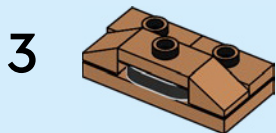
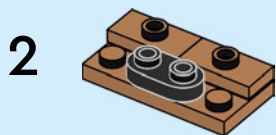

4

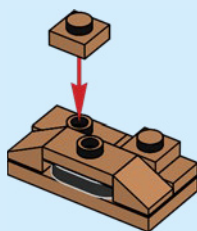

5

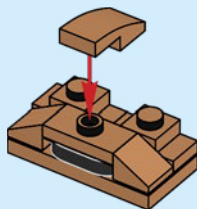

6

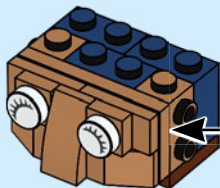
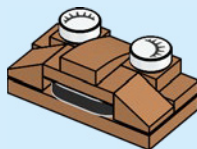

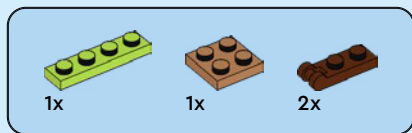

46

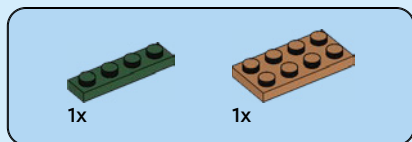
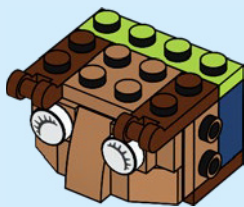

47

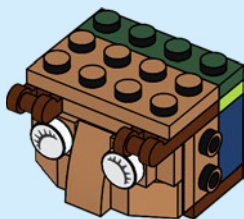

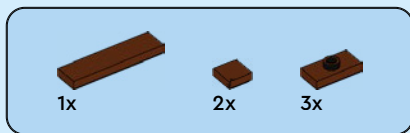

48

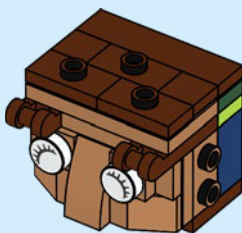

49

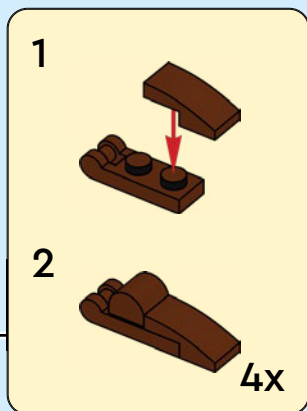
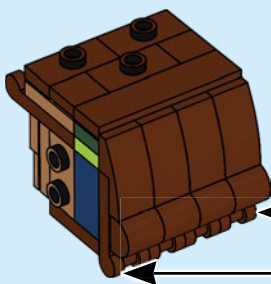



50

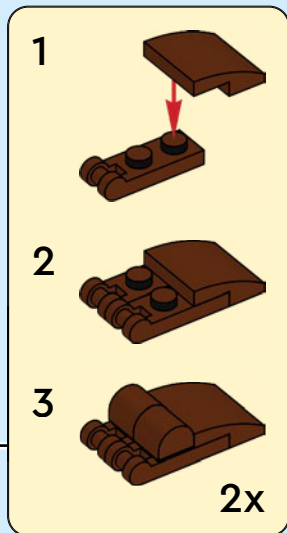
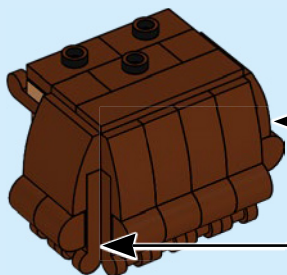

51

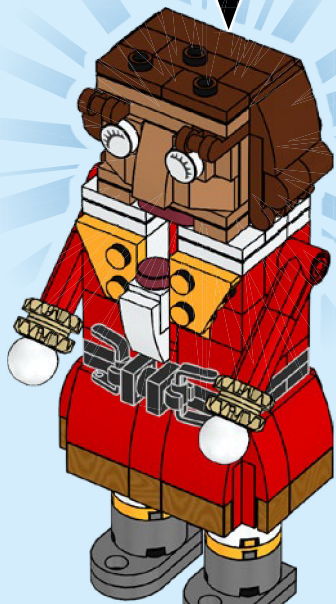

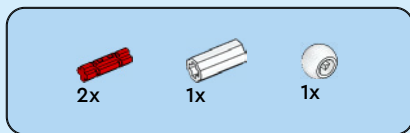

52

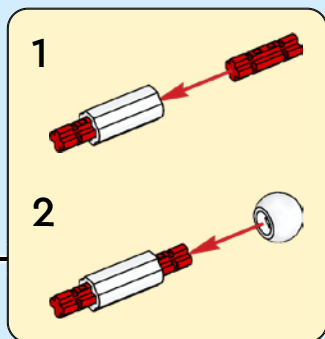
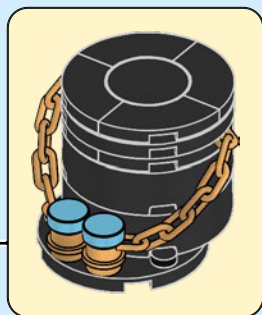









1x



1x

41

1

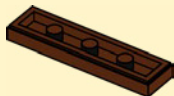

2

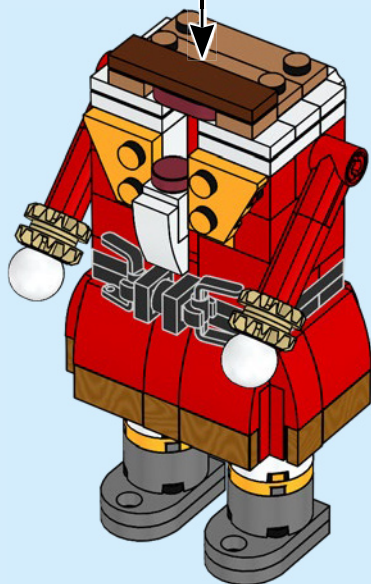
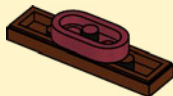



1x



1x

42

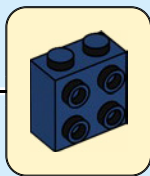
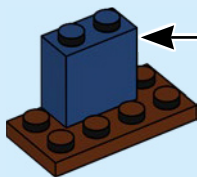

2x



2x

43

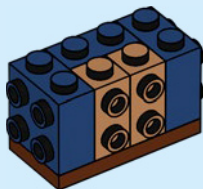



2x

44

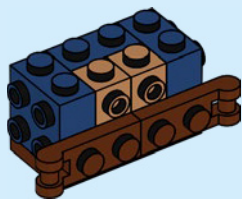

2x

45





4x

46

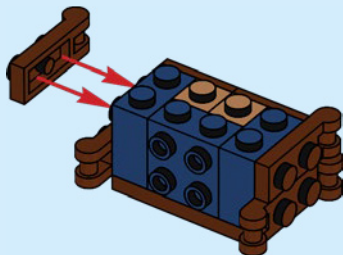

2x

47

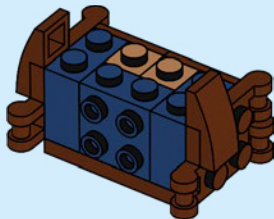

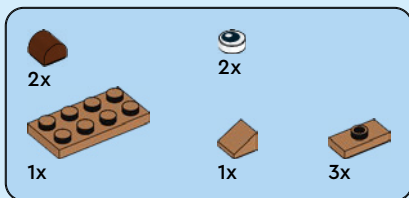

48

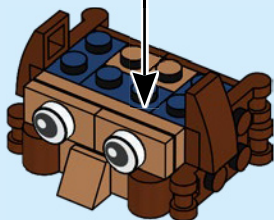
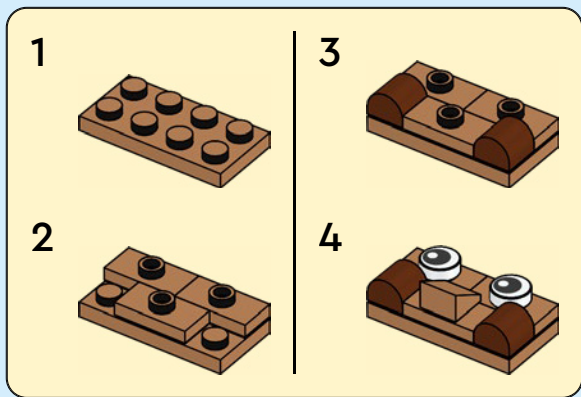



1x



4x

49

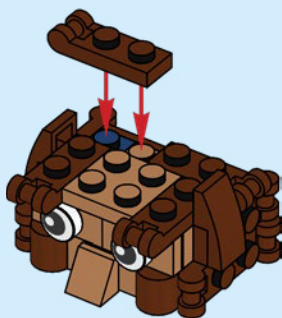

1x



1x

50

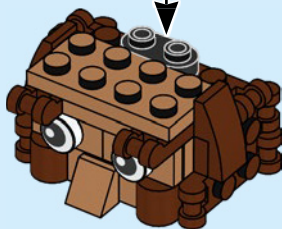



2x

51

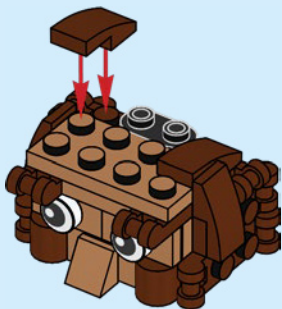

2x



3x

52

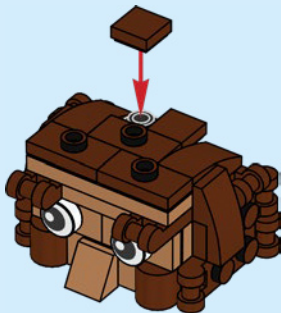

53

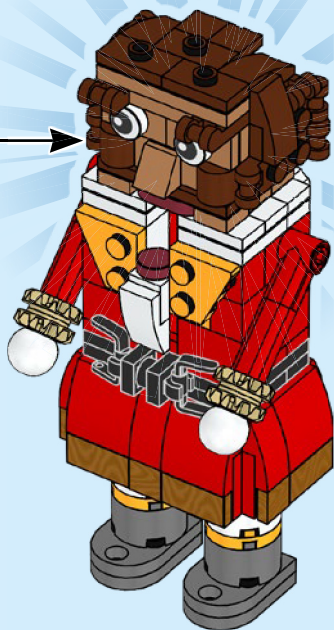

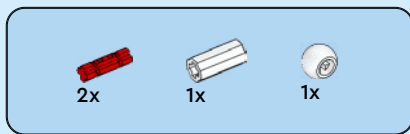

54

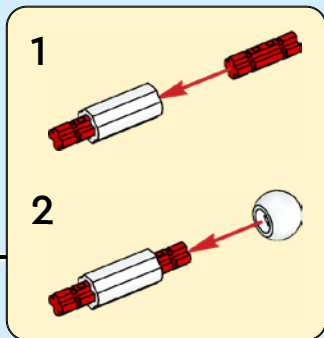
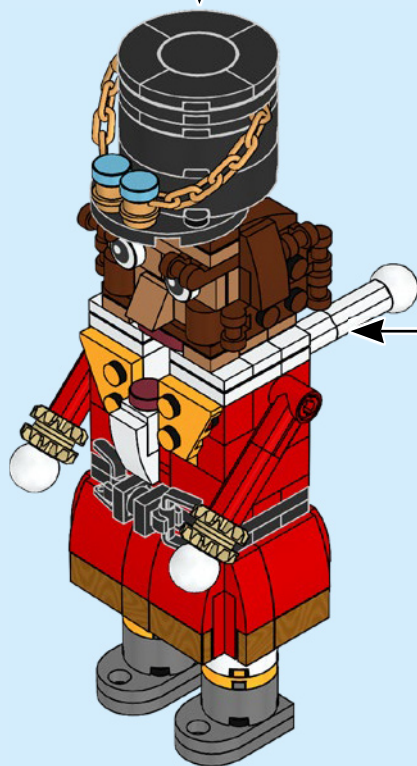
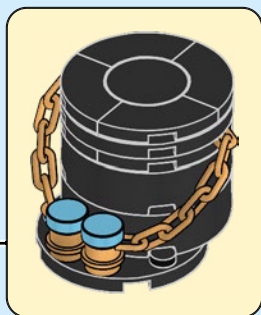

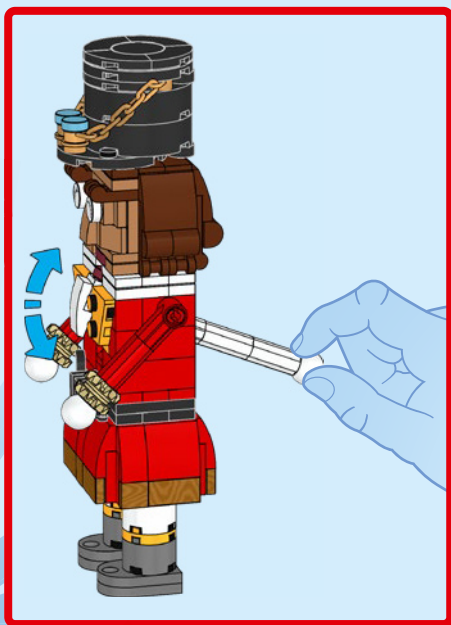
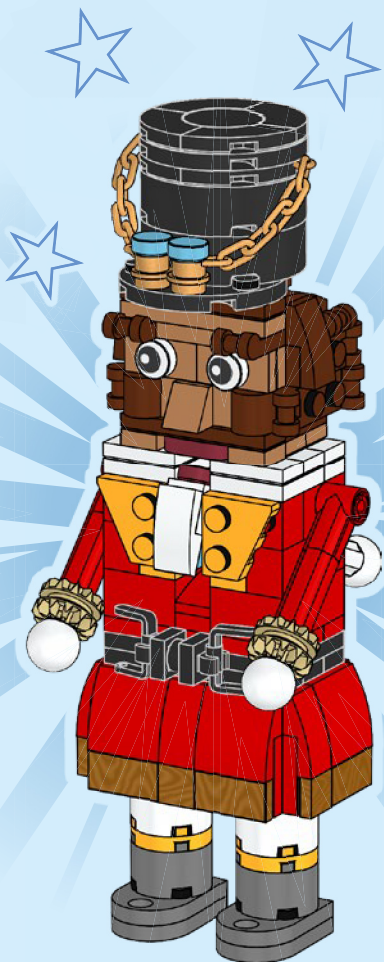



REBUILD INTO



SE TRANSFORME EN

CONVIÉRTELO



1x
4518400

2x
6284604

2x
6284599

3x
6052864

2x
6218841

1x
6296132

2x
614301

2x
6212049

6x
6051511

2x
6383982

1x
6034044

2x
302201

1x
6271870

1x
300201

1x
6350399

4x
4565452

1x
6321305

2x
6332580

2x
4558886

2x
654121

6x
4142865

2x
4513174

5x
6029946

6x
302321

6x
6105976

2x
6347696

2x
362221

2x
300221

4x
302121

3x
6371582

2x
6130007

2x
6335388

2x
6245281

4x
6210270

1x
6070695

1x
6281993

6x
6191630

2x
302126

2x
4515350

2x
4558957

3x
6350415

1x
6240515

2x
6208291

2x
6146888

1x
4187743

3x
6429965

4x
6192250

1x
6020923

1x
6303004

1x
6069257

2x
6184348

2x
6284585

1x
6212040

3x
6073040



1x
6296241



1x
6328059



3x
6385485



8x
6371437



2x
4211288



4x
6069984



3x
6092590



2x
6146858



10x
6102975



1x
4211194



1x
4211186



2x
4249139



4x
4225733



2x
6190252



2x
6323688



2x
6422082



2x
6167690



4x
6215606



3x
6292154



1x
6356566



1x
6056383



2x
6257605



1x
6102998



2x
6093494



2x
6322819



2x
4619652



5x
6264167



6x
6265247



[LEGO.com/service](https://www.lego.com/service)

YOU COULD

WIN



Scan this QR code or go to **LEGO.COM/PRODUCTFEEDBACK** and give us your short feedback about this LEGO® set for a chance to win a cool LEGO prize.

Terms and Conditions apply*

EN: YOU COULD WIN. Terms and Conditions apply* **DE: Du könntest GEWINNEN.** Es gelten die Teilnahmebedingungen* **FR: Tu pourrais GAGNER.** Des conditions s'appliquent* **IT: Potresti VINCERE tu.** Termini e condizioni sono applicabili* **ES: Puedes GANAR.** Aplican términos y condiciones* **PT: Poderá GANHAR.** Aplicam-se termos e condições* **ZH: 轻松获奖. 条款和条件适用*** **PL: Szansa na WYGRANĄ.** Obowiązują warunki korzystania* **CS: Máte šanci VYHRÁT.** Platí všeobecné smluvní podmínky* **SK: Máte šancu VYHRAŤ.** Platia všeobecné zmluvné podmienky* **HU: TE IS NYERHETSZ.** Felhasználási feltételek érvényesek* **RO: Ai putea CÂȘTIGA.** Se aplică termenii și condiții* **BG: Можете да СПЕЧЕЛИТЕ.** Има определени правила и условия* **LV: Tu vari LAIMĒT.** Ir spēkā noteikumi un nosacījumi.* **ET: Sul on võimalus VÕITA.** Kehtivad tingimused* **LT: Jūs galite LAIMĖTI.** Taikomos sąlygos*

*[LEGO.com/productfeedback-terms](https://www.lego.com/productfeedback-terms)